

An Roinn Talmhaíochta,
Bia agus Mara
Department of Agriculture,
Food and the Marine



7th December, 2018

Your Ref: AP11/2018

Our Ref: T10/081A & B

Ms Mary O' Hara
Secretary to the Board
Aquaculture Licences Appeals Board
Kilminchy Court
Dublin Road
Portlaoise
Co. Laois

Dear Ms O'Hara,

I acknowledge receipt of your letter to Mr. Michael Creed T.D., Minister for Agriculture, Food and the Marine (and copied to Mr. John Quinlan) regarding the appeal of the decision to refuse to grant Aquaculture and Foreshore Licences to Tony Mc Grath, Pulathomas, Ballina, Co Mayo.

Please find enclosed the requested documents and a schedule of same. If you require any further documentation please do not hesitate to contact me.

Consideration will be given as to whether the Minister will make any further submissions or observations under Section 44(2) of the Fisheries (Amendment) Act 1997 within the specified time frame.

Yours sincerely

Mary Mc Cull
Aquaculture & Foreshore Management Division
National Seafood Centre
Clogheen
Clonakilty
Co. Cork.

Phone: 023 8859517
Email: mary.mccull@agriculture.gov.ie

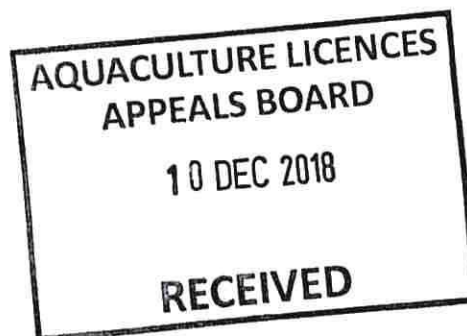

Schedule of Documents in relation to appeal to ALAB of the Minister's Decision to refuse to grant Aquaculture and Foreshore licences to Tony Mc Grath, Pulathomas, Ballina, Co Mayo Ref. T10/081A & B – AP11/2018

1. Application for Aquaculture and Foreshore licence renewal for T10/081 sites A & B, including maps and drawings.
2. Submission to Minister for Aquaculture Licence and Foreshore Licence.
3. Notification to applicant of Minister's decision.
4. Notification to ALAB of Minister's decision.
5. Publication of Ministerial decision in 'The Mayo News'.
6. Map of sites.

**AQUACULTURE AND FORESHORE LICENSING APPLICATION FORM, for purposes
of FISHERIES (AMENDMENT) ACT, 1997 and FORESHORE ACT, 1933**

Accompanying Guidance Notes should be read before completing this form.

Note: Details provided in Parts 1 and 2 will be made available for public inspection. Details provided in Part 3 are confidential and are not for public disclosure.

For Office Use
Application Ref. No. T10/81
Date of receipt, (Dept. Stamp):



USE BLOCK CAPITALS IN BLACK INK

PART 1: PRELIMINARY DETAILS

| | |
|--------------------------------------|-----------------------|
| Name(s) of Applicant(s) in full: | |
| I.A | <u>Tony M G Leath</u> |
| I.B | |
| Address(es) of Applicant(s) in full: | |
| I.A | <u>Pulathomas</u> |
| | <u>BALLINA</u> |
| | <u>Co. Mayo</u> |
| I.B | |
| Fax: | |

I.C TYPE OF APPLICATION
Indicate the relevant type of application:

| | |
|---------------------------------------|-------------------------------------|
| - (i) Aquaculture Licence | <input type="checkbox"/> |
| - (ii) Trial Licence | <input type="checkbox"/> |
| - (iii) Review of Aquaculture Licence | <input type="checkbox"/> |
| - (iv) Renewal of Aquaculture Licence | <input checked="" type="checkbox"/> |
| - (v) Foreshore Licence | <input type="checkbox"/> |

Insert X in relevant box

(This Application Form is valid for each type of application.)

I.D TYPE OF AQUACULTURE
Indicate the relevant type of application:

| | |
|---------------------|-------------------------------------|
| - (i) Land-based | <input type="checkbox"/> |
| - (ii) Marine-based | <input checked="" type="checkbox"/> |
| - Shellfish | |
| (iii) - extensive | <input type="checkbox"/> |
| (iv) - intensive | <input checked="" type="checkbox"/> |
| - (v) Finfish | <input type="checkbox"/> |

1. DOCUMENTS ENCLOSED WITH THIS APPLICATION

The following documents are enclosed with this application:

(1) - Ordnance Survey Map (Scale of 1: 10,560, ie, a six inch map) **OBLIGATORY**

(2) - British Admiralty Chart (largest available scale)

(3) - Decision of planning authority under Planning Acts

(4) - Copy of licence under Section 4 of Local Government
Water Pollution) Act, 1977

(5) - Environmental Impact Statement

(6) - Drawing of the structures to be used and/or the layout of the farm **OBLIGATORY**

(7) - Water Quality Analysis Report (required for Land-based sites only)

(8) - Application Fee **OBLIGATORY**

(9) - Other (specify): _____

PART 2: DETAILS RELATING TO PROPOSED AQUACULTURE PROJECT

2.A Employment, Qualifications, Experience, Etc.

(i) Details of Applicant's qualifications and experience in aquaculture: 30 YEARS IN

SHELLFISH + FISHING INDUSTRY

(ii) Other relevant experience (courses attended, etc): _____

(iii) Details of projected employment creation during first four years of proposed development: _____

HAVE EXISTING SITE FOR PAST 20 YEARS.

(iv) Projected employment (number of persons):

| | | | | | | | |
|---------|----------|---------|----------|---------|----------|---------|----------|
| Year 1: | <u>2</u> | Year 2: | <u>2</u> | Year 3: | <u>2</u> | Year 4: | <u>2</u> |
|---------|----------|---------|----------|---------|----------|---------|----------|

Land-based Site (continued)

2.D The following must be supplied:

- (i) Sketch of the layout of the site in relation to the river(s), road(s) and buildings;
- (ii) Water quality Analysis Report, which should be drawn up in accordance with the parameters set out in Annex C of the Guidance Notes.

2.E The following conditions must be met in order to allow for consideration of licensing of land-based aquaculture:

- (i) the buildings and equipment must be put in place to the Department's satisfaction; and
- (ii) the operation must comply with Local Authority requirements.

2.F Marine-based Site(s)

(To be completed if appropriate)

- Location - (i) Bay: Broadhaven Bay - Sruwaddacaw Bay
- (ii) County: MAYO
- (iii) OS Map No: MAYO 4
- (iv) Site Co-ordinates: Attached.
- (v) Size (hectares):
SITE A = 3.80 Ha + SITE B = 0.435 Ha TOTAL 4.235 Ha
- (vi) Species (common and scientific name): PACIFIC OYSTERS
diage Oysters CRASSOSTREA GIGAS
-Aquatic Plant(s)
-Any form of aquatic food suitable for the nutrition of fish
- (vi) Method of culture (e.g., nets, ropes, tanks, trestles, etc.): Trestles + Bags
- (vii) Drawings of structures to be used in method of culture should be enclosed. yes
- (viii) If cages or tanks are proposed, state:
- (a) Number: _____
- (b) Type and shape: _____
- (c) Cubic Capacity: _____
- (d) Depth: _____
- (ix) Proposed specific site locations (with reasons): THIS IS A RENEWAL
LICENSE APPLICATION
- (x) Describe proposed purification facilities to be used, where appropriate: _____

Marine-based Site(s) (continued)

2.G Give details of any special requirements relating to the health of the proposed project and the wider matters of public health and safety: _____

MARINE SHELLFISH HEALTH MANAGEMENT PLAN
+ ANTIHERSANOXIN NUMBER 298

2.H Tonnage to be produced:

| <u>Species</u> (To state) | <u>Year 1: 2013</u> | <u>Year 2: 2015</u> | <u>Year 3: 2016</u> | <u>Year 4: 2017</u> |
|------------------------------|---------------------|---------------------|---------------------|---------------------|
| <u>CRASSOSTREA GIGAS</u> | <u>5t</u> | <u>7t</u> | <u>10t</u> | <u>20t</u> |
| _____ | _____ | _____ | _____ | _____ |
| _____ | _____ | _____ | _____ | _____ |
| _____ | _____ | _____ | _____ | _____ |
| _____ | _____ | _____ | _____ | _____ |

2.I Reasons for selection of site(s): existing site

Note: The proposed access route to the site(s) from public road across tidal foreshore area must be indicated on the OS map accompanying the application.

2.J Environmental Impact Statement (EIS)

A copy of an EIS, if required, should be enclosed with the application. The EIS should contain the information specified in Annex B of the Guidance Notes.

2.K Trial Licence

(To be completed if appropriate)

Describe experimental or investigative nature of the proposed project: _____

[Use separate page if required - to be signed and dated]

B. MARKETING (continued)

3. Will the product be processed or packaged?

YES NO

4. If yes, give details: _____

I/We hereby declare the information provided in Parts 1, 2 and 3 above to be true to the best of my/our knowledge. I/We enclose an application fee* of € 63.49 with this application.

Signature(s) of Applicant(s):

Tony M. Smith

Date:

1.4.2012

*Preferred method of payment is by cheque or bank draft. The fee should be made payable to the Department of Agriculture, Food and the Marine.

This form should be forwarded, with the required documents and application fee, to:

Aquaculture Licensing
Aquaculture & Foreshore Management Division
Department of Agriculture, Food and the Marine
National Seafood Centre,
Clonakilty,
Co. Cork

1 NO. SITE AT BROADHAVEN BAY CO.MAYO

Co-ordinates & Area

Site T10/081A (3.8 Ha)

The area seaward of the high water mark and enclosed by a line drawn from Irish National Grid Reference point

082349, 338000 to Irish National Grid Reference point
082450, 338000 to Irish National Grid Reference point
082550, 337800 to Irish National Grid Reference point
082500, 337750 to Irish National Grid Reference point
082550, 337650 to Irish National Grid Reference point
082561, 337464 to Irish National Grid Reference point
082524, 337461 to Irish National Grid Reference point
082510, 337640 to Irish National Grid Reference point
082450, 337755 to the first mentioned point.

1 NO. SITE AT BROADHAVEN BAY CO.MAYO

Co-ordinates & Area

Site T10/081B (0.435 Ha)











The area seaward of the high water mark and enclosed by a line drawn from Irish National Grid Reference point

082534, 337331 to Irish National Grid Reference point
082568, 337330 to Irish National Grid Reference point
082570, 337291 to Irish National Grid Reference point
082649, 337239 to Irish National Grid Reference point
082620, 337220 to Irish National Grid Reference point
082540, 337279 to the first mentioned point.



Aqua Culture Sites

Site Status

-  Application
-  Application Lapsed
-  Application Refused
-  Application Renewed
-  Withdrawn
-  License Altered
-  License Revised
-  License Surrendered
-  Licensed
-  Unlicensed
-  Unlicensed

1:10,560

Site Highlighted in red denotes Application

Printed under License No: Z708
 From The Ordnance Survey
 Copyright Government of Ireland 2008.
 Unauthorised Reproduction is not permitted





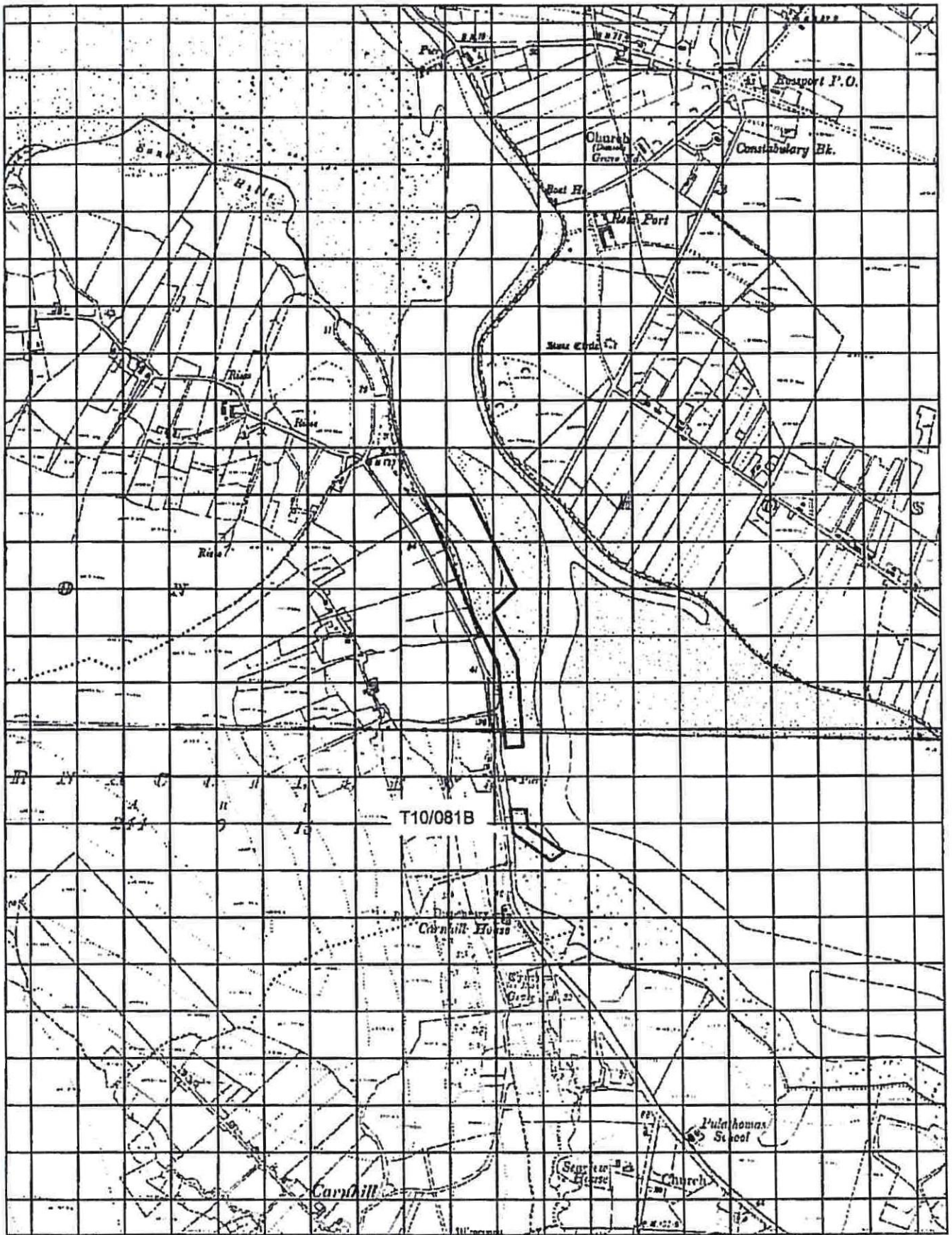







Department of
**Agriculture,
 Food and the Marine**
 An Roinn
**Talmhaíochta,
 Bia agus Mara**



Aqua Culture Sites

Site Status

-  Application
-  Application Lapsed
-  Application Refused
-  Application Renewal
-  Withdrawn
-  License Altered
-  License Revoked
-  License Surrendered
-  Licensed
-  Unknown
-  Unstarted

1:10,560

Site Highlighted in red denotes Application

Printed under License No. 2706
 From The Ordnance Survey.
 Copyright Government of Ireland 2008.
 Unauthorised Reproduction is not permitted





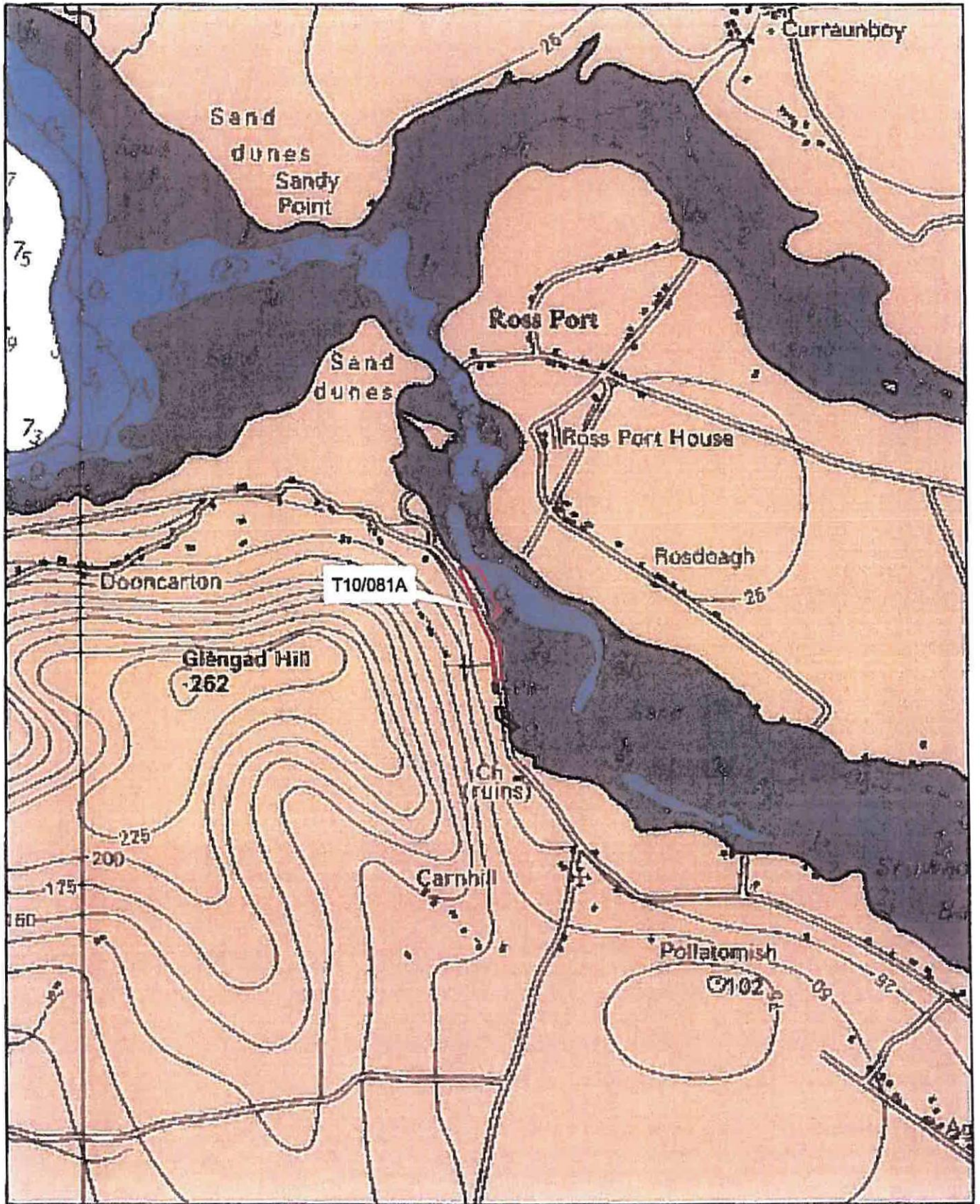







Department of
**Agriculture,
 Food and the Marine**
 An Roinn
**Talmhaíochta,
 Bia agus Mara**



Aqua Culture Sites

Site Status

-  Application
-  Application Lapsed
-  Application Refused
-  Application Renewal
-  Withdrawn
-  License Altered
-  License Revoked
-  License Surrendered
-  Lapsed
-  Unknown
-  Unclassified

1:24,000

Site Highlighted in red denotes Application

Part of Admiralty Chart No 2703-0

Not to be used for Navigation.



Department of
**Agriculture,
Food and the Marine**
An tAire
Talmhaíochta,
Bia agus Mara

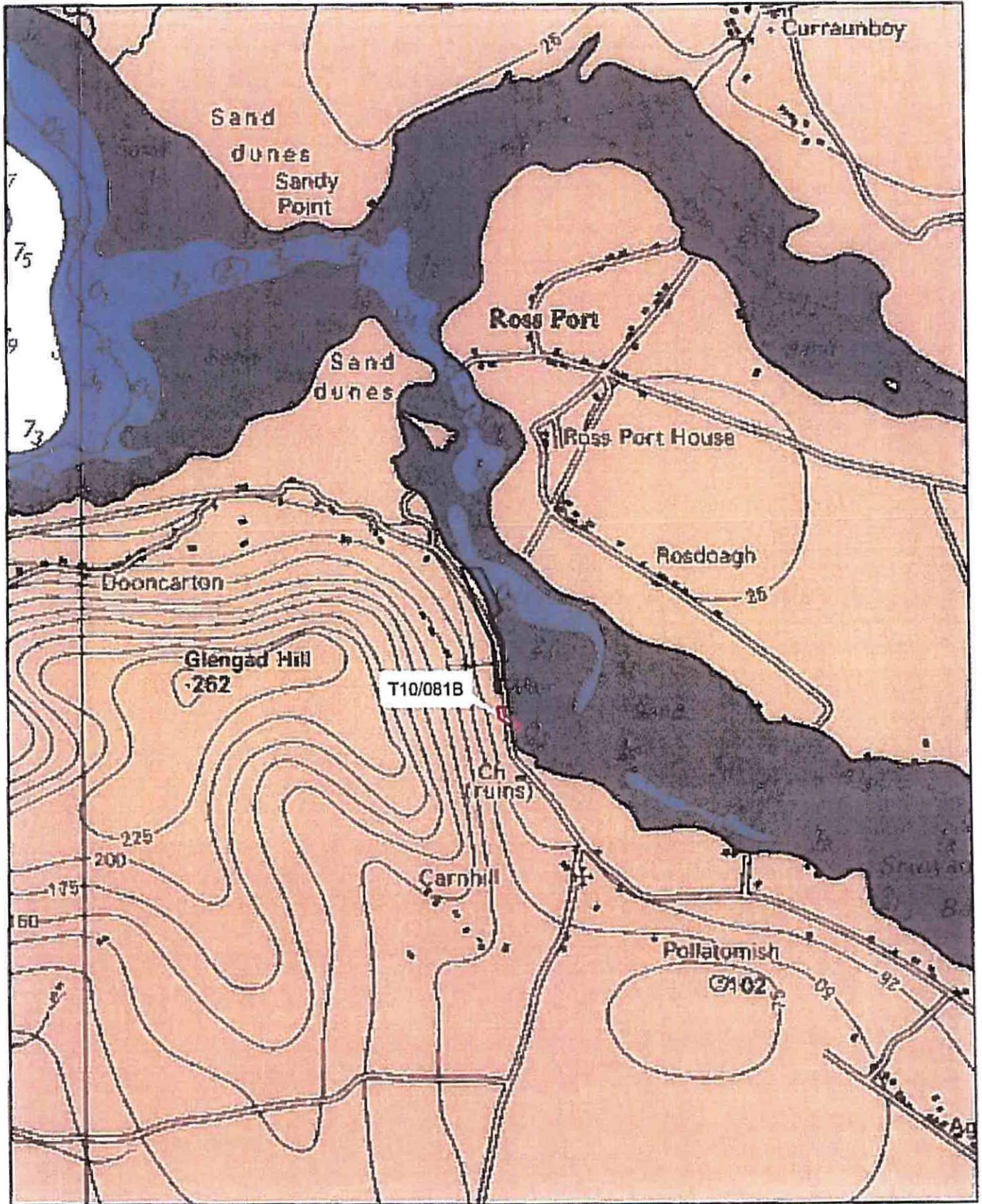

- Aqua Culture Sites**
- Site Status**
- Application
 - Application Lapsed
 - Application Refused
 - Application Renewed
 - Withdrawn
 - License Altered
 - License Revoked
 - License Surrendered
 - Licensed
 - Unknown
 - Unclassified

1:24,000

Site Highlighted in red denotes Application

Part of Admiralty Chart No 2703-0
Not to be used for Navigation.



Department of
**Agriculture,
Food and the Marine**
An Roinn
Talmhaíochta,
Bia agus Mara

TONY Mc GRATH 7/0/81
SITE LAYOUT
TOTAL SITE = 4,235 hectares

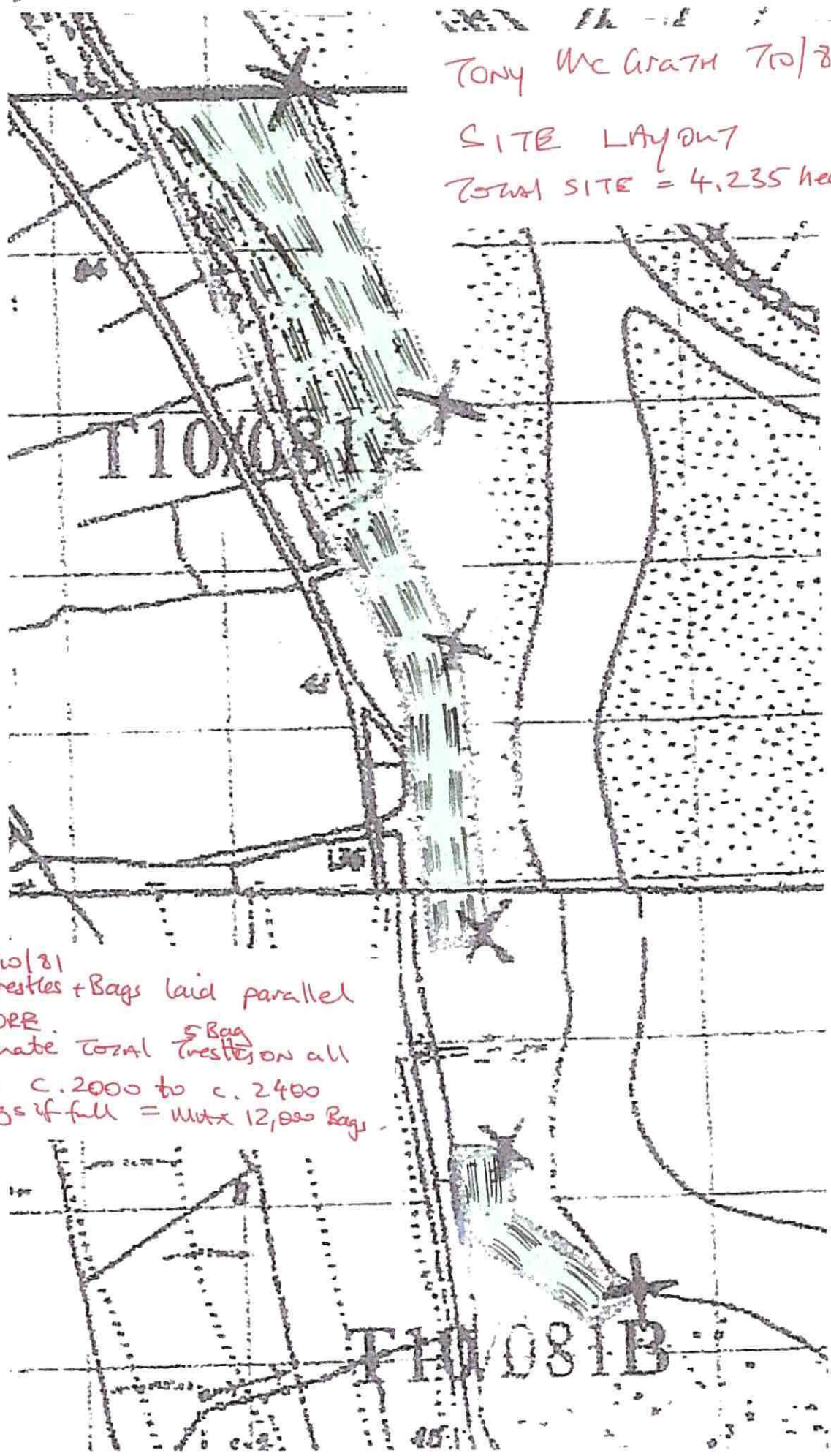

SITE 7/0/81
Oyster Trestles + Bags laid parallel
to SHORE.
Approximate total ^{5 Bag} trestles on all
of SITE c. 2000 to c. 2400
with bags if full = $1100 \times 12,000$ Bags

Aquaculture Licence Renewal: Tony McGrath T10/81

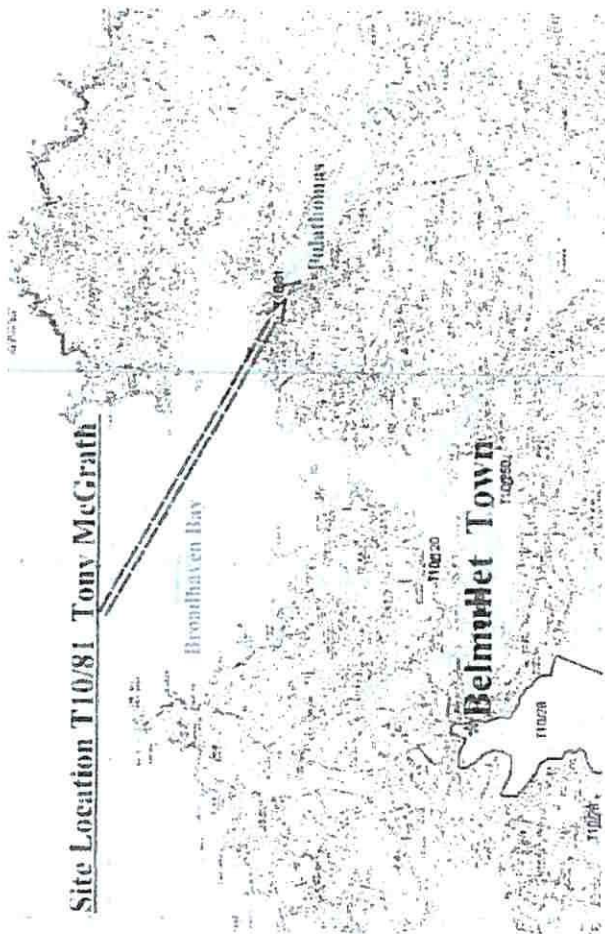

Example of Oyster bags on trestles in rows

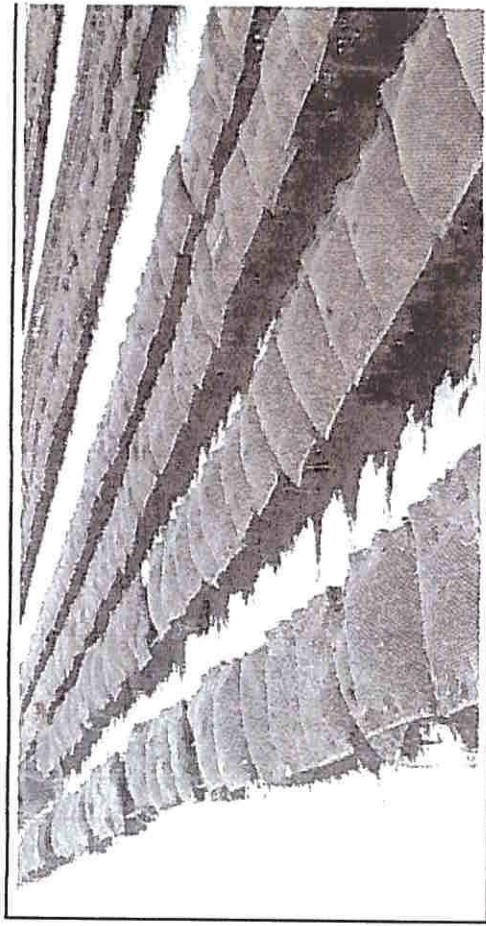

Yellow Special Marker Poles with St. Andrews Cross.
This is approximately 7 metres in height and the yellow sleeve and cross is visible 2 metres above high tide.

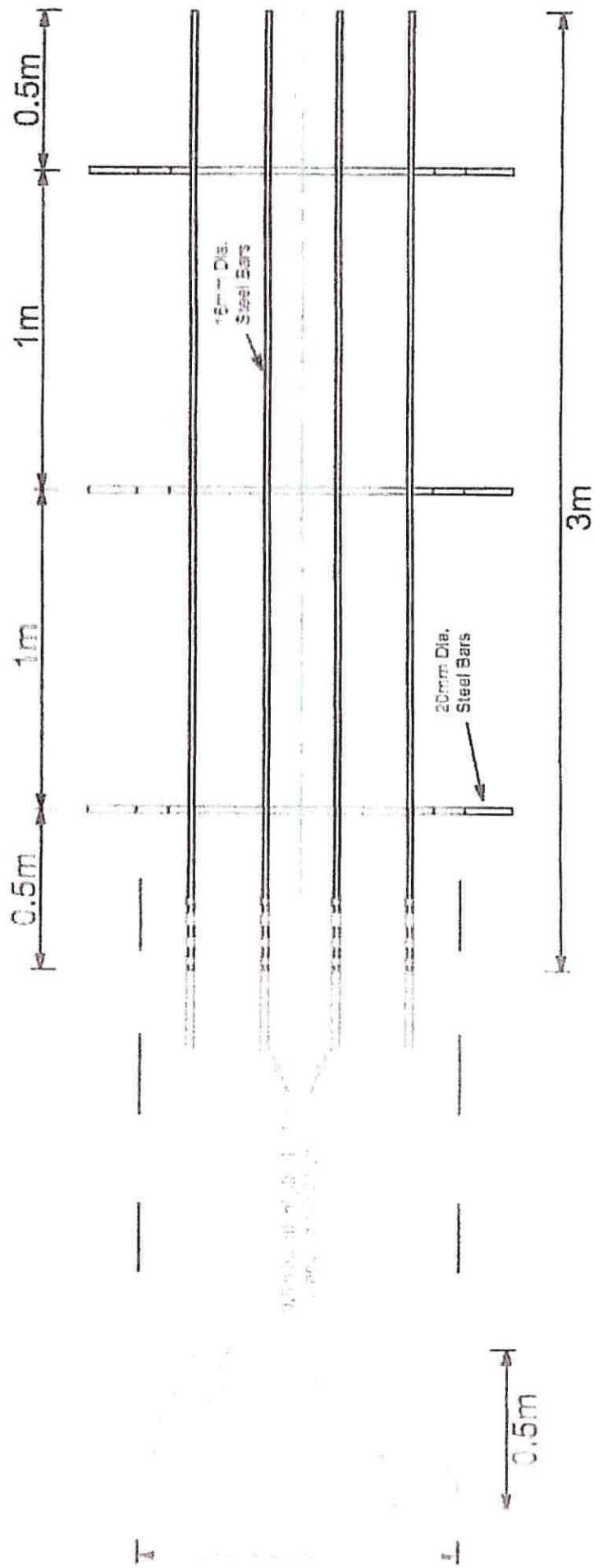
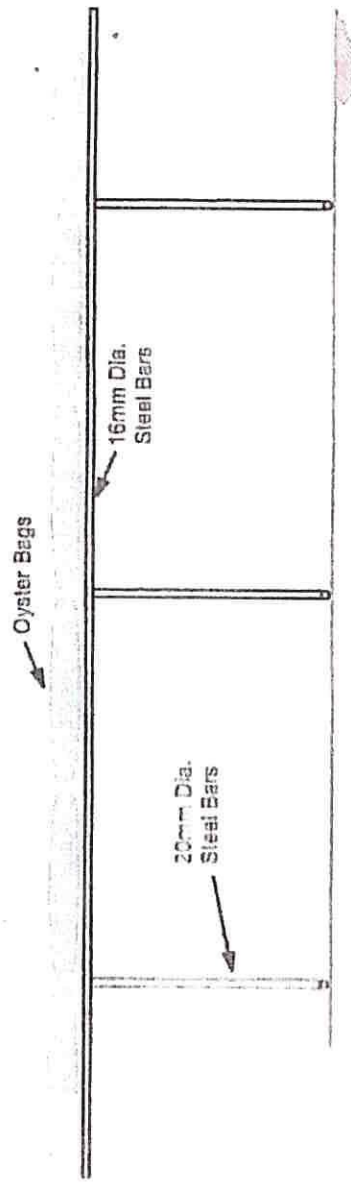
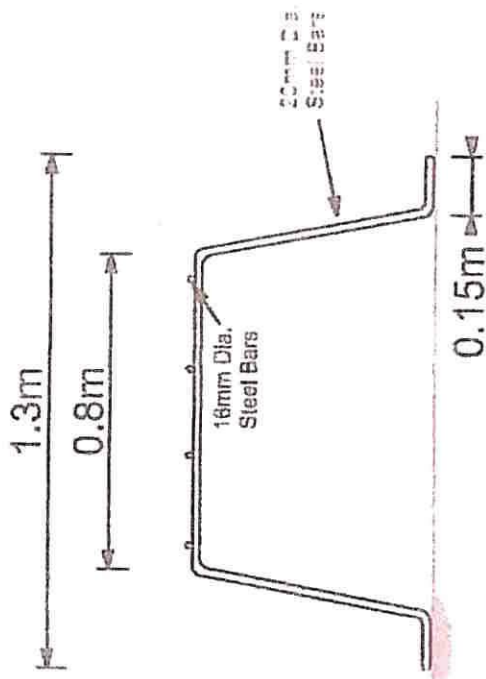

Typical Oyster Bag

Plan (Bags not shown for clarity)

Submission AGR 00490-18: Recommendation to refuse Aquaculture Licences (T10/81)

TO: Minister
STATUS: Completed
PURPOSE: For Decision

AUTHOR: McCull, Mary
OWNER: McCull, Mary
REVIEWERS: OConnell, James
Whelton, Batt
Quinlan, John
Beamish, Cecil

DIVISION: Coastal Zone Management
DECISION BY:

Final comment

Minister determines that the application for Aquaculture and Foreshore licences be refused for the reasons outlined.

Action required

Ministerial determination on an Aquaculture/Foreshore Licensing Application(T10/81)

Executive summary

The Minister's determination is requested in relation to a renewal application for Aquaculture Licences from Tony McGrath, Pulathomas, Ballina, Co Mayo for 2 sites in Sruwaddacon Bay, Broadhaven, Co Mayo.

A submission in respect of the accompanying Foreshore Licences is also set out below, for the Minister's consideration.

It is recommended that the Minister determines that the application for Aquaculture and Foreshore licences **be refused** for the reasons outlined in the 'Detailed Information' section below.

Detailed information

Recommendation to refuse Aquaculture Licences (T10/81)

DECISION SOUGHT

The Minister's determination is requested in relation to a renewal application for an Aquaculture Licence from Tony Mc Grath, Pulathomas, Ballina, Co Mayo, for 2 sites in Sruwaddacon Bay, Broadhaven, Co. Mayo.

A submission in respect of the accompanying Foreshore Licence is also set out below, for the Minister's consideration.

BACKGROUND

Marine aquaculture operations require separate Aquaculture and Foreshore Licences and Ministerial approval is required in respect of this submission (Aquaculture Submission) and submission underneath (Foreshore Submission), which refer to the same site.

The Aquaculture Licence defines the activity that is permitted on a particular site and the Foreshore Licence allows for the occupation of that particular area of foreshore. The continuing validity of each licence is contingent on the other licence remaining in force.

APPLICATION FOR AN AQUACULTURE LICENCE

A renewal application for an Aquaculture Licence has been received from the applicant referred to above (in conjunction with an application for a Foreshore Licence), for the cultivation of Pacific Oysters using bags and trestles in relation to 2 sites totalling 4.235 hectares on the foreshore in Sruwaddacon Bay, Broadhaven, Co. Mayo (numbered T 10/81A, T10/81B – see TAB A).

LEGISLATION

Section 7 of the Fisheries (Amendment) Act 1997 provides that the licensing authority (i.e. Minister, delegated officer or, on appeal, the Aquaculture Licences Appeals Board) may, if satisfied that it is in the public interest to do so, licence a person to engage in aquaculture.

Article 6 (3) of the Habitats Directive provides that *“Any plan or project not directly connected with or necessary to the management of the site but likely to have a significant effect thereon ... shall be subject to appropriate assessment of its implications for the site in view of the site's conservation objectives ... the competent national authorities shall agree to the plan or project only after having ascertained that it will not adversely affect the integrity of the site concerned ... ”*

CONSULTATION AND PUBLIC COMMENT

The application was sent to the Department's technical experts, statutory consultees and was also publicly advertised in a composite public notice covering both aquaculture and foreshore elements.

Technical Consultation

Engineering Division: MED reported that there were derelict trestles on the foreshore at both sites. There were no oyster bags or stock on site and the sites did not appear to be in use.

From a visual aspect there will be no obstruction or degradation of the views towards visually venerable features or significant alterations to the appearance or character of the sensitive area. The population density in the area is low and visibility of the site from public views is low. There is little other fishing and marine leisure in the area.

Marine Survey Office: Has no objection to the issue of Licences.

Sea Fisheries Protection Authority: The Sea Fisheries Officer (SFO) reported in December 2012 that the area was not currently classified for the harvesting of any bivalves under Council Directive 91/492/EEC. The sites would require a sanitary survey and a microbiological sampling regime for a period before any harvesting to determine its status. The applicant was advised at the time to contact the SFPA to arrange the necessary tests. No evidence of classification or sampling has been provided.

Statutory Consultation

Regulation 10 of the Aquaculture (Licence Application) Regulations, 1998 requires certain statutory bodies to be notified of an Aquaculture Licence application.

Comments were received from the following statutory bodies:

Dept of Culture, Heritage and the Gaeltacht (DCHG): The Department's report expressed concern regarding the information supplied in the Appropriate Assessment reports in relation to cumulative impacts, monitoring, boat activity, reliability of buffer zones and disturbance to seals. The Marine Institute (MI) responded to the issues raised and the responses are incorporated in the Department's Conclusion Statement. The MI stated that it did not see any need to revise the outputs or conclusions in the AA reports underpinning the assessment process.

Marine Institute: Has no objection to the issue of Licences. The Institute noted that the sites are not located within a

designated Shellfish Growing Waters Area. The Institute recommended that the Operator take all precautions possible to avoid introducing invasive non-native species on to the sites. They further recommended that prior to commencement of any possible operations the applicant be required to draw up a contingency plan, for the approval of DAFM, which will identify methods for the removal from the environment of any invasive non-native species introduced as a result of operations at the sites. This will be a condition of any aquaculture licence issued.

Commissioner of Irish Lights: Has no objection to the issue of licences.

Inland Fisheries Ireland: Has no objection to the issue of licences provided that the area is adequately marked and that all seed is sourced from a certified, disease free stock. (The latter issue falls under the remit of the Fish Health unit of the Marine Institute.)

BIM: Has no objection to the issue of Licences.

Public Consultation

The application was publicly advertised using a composite public notice covering both aquaculture and foreshore elements, in 'The Mayo News' on 1st May, 2018. The application and supporting documentation were available for inspection at Belmullet Garda Station for a period of 4 weeks from the date of publication of the notice in the newspaper.

There were no objections/comments received from the public consultation process.

CRITERIA IN MAKING LICENSING DECISIONS

The licensing authority, in considering an application, is required by statute to take account of, as appropriate, the following points and must also be satisfied that it is in the public interest to license a person to engage in aquaculture:

a) the suitability of the place or waters

The SFO reported in December 2012 that the area was not currently classified for the harvesting of any bivalves under Council Directive 91/492/EEC. The sites would require a sanitary survey and a microbiological sampling regime for a period before any harvesting to determine its status. The applicant was advised at the time to contact the SFPA to arrange the necessary tests. No evidence of classification or sampling has been provided.

b) other beneficial uses of the waters concerned

Public access to recreational and other activities can be accommodated by this project;

c) the particular statutory status of the waters

(i) Natura 2000

The sites are located within the Glenamoy Bog Complex SAC and Blacksod Bay/Broadhaven Bay SPA. An Article 6 Appropriate Assessment has been carried out in relation to aquaculture activities in this SAC. This Assessment and its findings were examined by the Department and its scientific/technical advisors. This led to the Licensing Authority (i.e. the Minister) producing a Conclusion Statement outlining how it is proposed to licence and manage aquaculture activities in the above Natura sites in compliance with the EU Habitats and Birds Directives.

In this case the Appropriate Assessment report stated that there had been no recent production on the

Sruwaddacon Bay sites, as the producer reported that the massive landslide in this area in 2003 had a detrimental effect on the site.

(ii) Shellfish Waters

The sites are not located within Shellfish Designated Waters.

d) the likely effects on the economy of the area

Aquaculture has the potential to provide a range of benefits to the local community, such as attraction of investment capital, development of support services, etc.

e) the likely ecological effects on wild fisheries, natural habitats, flora and fauna

No significant issues arose regarding wild fisheries. The potential ecological impacts of aquaculture activities on natural habitats, flora and fauna are addressed in the Article 6 Appropriate Assessment for the Glenamoy Bog Complex SAC and the Blacksod Bay/Broadhaven Bay SPA, and in the Licensing Authority's Conclusion Statement.

f) the effect on the environment generally

The Minister is obliged pursuant to Regulation 5 (2) of Licence Applications Regulations to consider on a case by case basis whether the proposed aquaculture is likely to have significant effect on the environment.

No chemicals or hazardous substances will be used during the production process.

The cultivation of shellfish at these sites would produce faeces and pseudofaeces. Any impact would be limited to the area of the sites. The build-up of excess organic matter beyond the footprint of the sites is not considered likely. On the basis of targeted research, the impact of intertidal oyster cultivation using bags and trestles on the majority of marine community types is considered not significant. From a visual aspect there will be no obstruction or degradation of the views towards visually venerable features or significant alterations to the appearance or character of the sensitive area

DCHG raised no objection to the development from an underwater archaeological perspective

RECOMMENDATION

It is recommended that the Minister:

refuses the granting of renewed Aquaculture Licences to Tony Mc Grath, Pulathomas, Ballina, Co. Mayo as the evidence available to the Department indicates that the applicant had not used the site for a number of years. The Appropriate Assessment report states the sites have not been used for a number of years and the Department's Engineer reported that the sites were in a derelict state.

REASONS FOR DECISION

The Minister for Agriculture, Food and the Marine is required to give public notice of both the licensing determination and the reasons for it. To accommodate this, it is proposed to publish the following on the Department's website, subject to the Minister approving the above recommendation:

"Determination of Aquaculture/ Foreshore licensing application – T10/81

Tony Mc Grath has applied for further authorisation to cultivate Pacific Oysters using bags and trestles on

the inter-tidal foreshore on 2 sites totalling 4.235 hectares (T10/81A = 3.8ha, T10/81B = 0.435 ha) in Sruwaddacon Bay, Broadhaven, Co Mayo.

The Minister for Agriculture, Food and the Marine has determined that it is in public interest to refuse to grant the licences sought. In making his determination the Minister considered those matters which by virtue of the Fisheries (Amendment) Act 1997, and other relevant legislation, he was required to have regard. Such matters include any submissions and observations received in accordance with the statutory provisions. The reasons and considerations for the Minister's determination to refuse to grant the licences sought is that the sites have been in a state of disuse during much of the previous licensed period and, consequently, it would not be in the public interest to grant further licences for aquaculture at these two sites."

Recommendation to refuse to grant a Foreshore Licence application (T10/81)

DECISION SOUGHT

The Minister's determination is requested in relation to an application for Foreshore Licences from Tony Mc Grath, Pulathomas, Ballina, Co. Mayo, for 2 sites in Broadhaven Bay, Co. Mayo, in which it is proposed to conduct aquaculture.

BACKGROUND

Marine aquaculture operations require separate Aquaculture and Foreshore Licences and Ministerial approval is required in respect of this submission (Foreshore Submission) and submission above (Aquaculture Submission), which refer to the same site.

The Foreshore Licence allows for the occupation of the particular area of foreshore while the Aquaculture Licence defines the activity that is permitted in this area. The continuing validity of each licence is contingent on the other licence remaining in force.

APPLICATION FOR A FORESHORE LICENCE

An application for a Foreshore Licence has been received from the applicant referred to above (in conjunction with an Aquaculture Licence application), relating to the occupation of the foreshore associated with the Aquaculture Licence application which covers 2 sites totalling 4.235 hectares (T10/81A = 3.8ha, T10/81B = 0.435 ha) (numbered **T10/81A and T10/81B** – see TAB A).

LEGISLATION

Section 3 of the Foreshore Act, 1933 gives power to the Minister to licence the use of foreshore, if he is of the opinion that it is in the public interest to do so.

CONSULTATION AND PUBLIC COMMENT

The application was sent to the Department's technical experts, and was also publicly advertised in a composite public notice covering both aquaculture and foreshore elements.

This application was also sent to the Department of the Housing, Planning and Local Government (DHPLG) in accordance with subsection (1B) of Section 3 of the Foreshore Act, 1933, which requires consultation between the Minister for Agriculture, Food and the Marine and the Minister for Housing, planning and Local Government. Whilst aquaculture legislation requires certain statutory bodies to be notified of an aquaculture application, no other statutory bodies are prescribed consultees under Fisheries related foreshore legislation.

DHPLG: No comments were received from a water quality or Foreshore perspective.

Technical Consultation

Marine Engineering Division: MED reported that there were derelict trestles on the foreshore at both sites. There were no oyster bags or stock on site and the sites did not appear to be in use.

Marine Survey Office: Has no objection to the issue of Licences.

Sea Fisheries Protection Authority: The Sea Fisheries Officer (SFO) reported in December 2012 that the area was not currently classified for the harvesting of any bivalves under Council Directive 91/492/EEC. The sites would require a sanitary survey and a microbiological sampling regime for a period before any harvesting to determine its status. The applicant was advised at the time to contact the SFPA to arrange the necessary tests. No evidence of classification or sampling has been provided.

Public Consultation

The application was publicly advertised using a composite public notice covering both aquaculture and foreshore elements, in the 'The Mayo News' on 1st May, 2018. The application and supporting documentation were available for inspection at Belmullet Garda Station for a period of 4 weeks from the date of publication of the notice in the newspaper.

There were no objections/comments received from the public consultation process.

CRITERIA IN MAKING LICENSING DECISIONS

The Minister, in considering an application for a Foreshore Licence, may, if satisfied that it is in the public interest to do so, grant such a licence.

Section 82 of the Fisheries (Amendment) Act, 1997 stipulates that the Minister, in considering an application for a licence under the Foreshore Acts, which is sought in connection with the carrying on of aquaculture pursuant to an Aquaculture Licence, shall have regard to any decision of the licensing authority in relation to the Aquaculture Licence.

RECOMMENDATION

It is recommended that the Minister, taking account of the decision on the related aquaculture licence application:

refuses the granting of Foreshore Licences to Tony Mc Grath, Pulathomas, Ballina, Co. Mayo for 2 sites in Broadhaven Bay, Co Mayo as the sites have been in a state of disuse during much of the previous licensed period.

Submitted for approval

Related submissions

There are no related submissions.

Comments

OConnell, James - 02/08/2018 14:49

It is recommended that the Minister refuses to grant Aquaculture/ Foreshore licence(s) to Mr Tony McGrath for licensing application T10/81 for the reasons outlined in the submission above

Whelton, Batt - 13/08/2018 15:20

I agree with the recommendation that this renewal application for 2 sites be refused as the sites have been in a state of disuse during much of the previous licensed period

Quinlan, John - 03/09/2018 14:52

Refusal is recommended in this case as set out in the detailed submission.

Beamish, Cecil - 06/09/2018 10:47

Recommended that the Minister determines that the application for Aquaculture and Foreshore licences be refused for the reasons outlined in the Submission.

Smith, Ann - 07/09/2018 09:54

Approved for submission to Minister. 07/09/2018

User details

INVOLVED: McCull, Mary
OConnell, James
Whelton, Batt
Quinlan, John
Beamish, Cecil
Sub Sec Gens Office
eSub Ministers Office

READ RECEIPT: McCull, Mary
BTSSP-SC
OConnell, James
Whelton, Batt
Quinlan, John
Beamish, Cecil
Smith, Ann
Lennox, Graham

13th September 2018

Ref: T10/081

Mr Tony Mc Grath
Pulathomas
Ballina
Co Mayo

COPY

**FISHERIES (AMENDMENT) ACT, 1997 (NO.23)
NOTICE OF MINISTERIAL DECISION TO REFUSE TO GRANT AN
AQUACULTURE LICENCE AND FORESHORE LICENCE.**

Dear Mr Mc Grath

I would like to inform you that the Minister For Agriculture, Food and the Marine has refused your application for renewal of Aquaculture Licences and Foreshore Licences, for the cultivation of Oysters using bags and trestles on sites no. T10/081A and T10/081B (see attached information note). I enclose a copy of the public notice of the decision which **the Department** has arranged to have published in "The Mayo News".

Any person aggrieved by the decision may, in accordance with Section 41 of the Fisheries (Amendment) Act 1997, appeal against it in writing to the Aquaculture Licences Appeals Board. This appeal must be lodged within one month beginning on the date of the publication of the decision.

In addition, a person may question the validity of the Foreshore Licence determination by way of an application for judicial review, under Order 84 of the Rules of the Superior Court (SI No. 15 of 1986). Practical information on the review mechanism can be obtained from the Citizens Information Board at:

<http://www.citizensinformation.ie/>

Yours sincerely

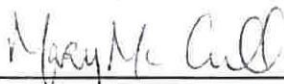

Aquaculture and Foreshore Management Division

**S.12 (3) OF THE FISHERIES (AMENDMENT) ACT, 1997(NO.23)
INFORMATION NOTE TO APPLICANT FOR THE PURPOSE OF REGULATION 18
OF THE AQUACULTURE (LICENCE APPLICATION) REGULATIONS 1998**

REFERENCE NO: T10/081

APPLICANT: Tony Mc Grath

**AQUACULTURE TO WHICH
DECISION RELATES:** Cultivation of Oysters using bags and trestles on
sites T10/081A and T10/081B on the foreshore in
Broadhaven Bay, Co Mayo.

NATURE OF DECISION: Refusal of Licence.

DATE OF DECISION: 10th September 2018

REASON FOR REFUSAL: The sites have been in a state of disuse during
much of the previous licensed period.

To be inserted in 'The Mayo News'

COPY

**FISHERIES (AMENDMENT) ACT, 1997(NO. 23)
FORESHORE ACT, 1933(No 12)**

NOTICE OF DECISIONS TO GRANT/ REFUSE AQUACULTURE AND FORESHORE LICENCES

The Minister for Agriculture, Food and the Marine **has decided to grant** Aquaculture and Foreshore Licences to those listed in the table below to carry out Aquaculture, on a number of sites on the foreshore in Co. Mayo.

| Ref No | Applicant's Name & Location of Site(s) | Species |
|-----------|--|--|
| T10/221/1 | Martin Colm, Luke and Olivia Henry, Blacksod Bay | Manila & Native Clams & Pacific Oysters |
| T10/237 | Gerard Heneghan, Blacksod Bay | Pacific and Native Oysters, Mussels, and Winkles |
| T10/319 | Redrose Developments Ltd., Broadhaven Bay | Seaweed - various |

The Minister for Agriculture, Food and the Marine **has decided to refuse to grant** Aquaculture and Foreshore Licences to;

Tony Mc Grath, for the cultivation of Pacific Oysters on the foreshore on 2 sites in Broadhaven Bay.

The reasons for these decisions are elaborated on the Department's website at: <http://www.agriculture.gov.ie/seafood/aquacultureforeshoremanagement/aquaculturelicensing/>

An appeal against the decisions may be made in writing, within one month of the date of this publication, to THE AQUACULTURE LICENCES APPEALS BOARD Kilminchy Court, Portlaoise, Co. Laois, by completing the Notice of Appeal application form available from the Board, phone 057 8631912, e-mail at info@alab.ie or website www.alab.ie

A person may question the validity of the Foreshore Licence determination by way of an application for judicial review, under Order 84 of the Rules of the Superior Court (SI No. 15 of 1986). Practical information on the review mechanism can be obtained from the Citizens Information Board at: <http://www.citizensinformation.ie/>

McCull, Mary

From: McCull, Mary
Sent: 14 September 2018 12:41
To: Alab, Info
Subject: Aquaculture Licence decisions
Attachments: ALAB letter.pdf; decision notices.pdf; Advert for press office.doc

Ref: T10/081, T10/221/1, T10/237 and T10/319

Hello Ladies,

Please see attached details regarding Aquaculture Licence decisions by the Minister for Co Mayo.

Regards

Mary McCull

Aquaculture & Foreshore Management Division,
National Seafood Centre,
Clonakilty,
Co Cork. P85TX47

Ph 023 8859517 Email: mary.mccull@agriculture.gov.ie



Department of
**Agriculture,
Food and the Marine**
An Roinn
**Talmhaíochta,
Bia agus Mara**

13th September 2018

To ALAB

File Ref: See below

COPY

**NOTIFICATION OF MINISTER'S DECISION TO GRANT/REFUSE
AQUACULTURE LICENCES AND FORESHORE LICENCES IN CO MAYO.**

Dear Ms O'Hara,

I enclose a copy of the Notice of the Minister's Decision to grant Aquaculture Licences to those listed in the table below:

| Ref No | Applicant's Name & Location of Site(s) | Species |
|--------------------|--|--|
| T10/221/1 A & B | Martin Colm, Luke and Olivia Henry, Blacksod Bay | Manila & Native Clams & Pacific Oysters |
| T10/237 | Gerard Heneghan, Blacksod Bay | Pacific and Native Oysters, Mussels, and Winkles |
| T10/319 | Redrose Developments Ltd., Broadhaven Bay | Seaweed - various |

I also enclose a copy of the Minister's Decision to refuse to grant Aquaculture and Foreshore Licences to:

T10/081A and B - Tony Mc Grath, for 2 sites in Broadhaven Bay, Co Mayo.

The advertisement of the Minister's decisions will appear in 'The Mayo News on 18th September 2018.

Yours sincerely,

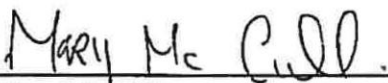
Mary McCull

Aquaculture and Foreshore Management Division
Department of Agriculture Food and the Marine
National Seafood Centre
Clonakilty, Co Cork
Email: mary.mccull@agriculture.gov.ie
Tel No: 023 8859517

**S.12 (3) OF THE FISHERIES (AMENDMENT) ACT, 1997(NO.23)
INFORMATION NOTE TO APPLICANT FOR THE PURPOSE OF REGULATION 18 OF
THE AQUACULTURE (LICENCE APPLICATION) REGULATIONS 1998**

REFERENCE NO: T10/081

APPLICANT: Tony Mc Grath

**AQUACULTURE TO WHICH
DECISION RELATES:** Cultivation of Oysters using bags and trestles on
sites T10/081A and T10/081B on the foreshore in
Broadhaven Bay, Co Mayo.

NATURE OF DECISION: Refusal of Licence.

DATE OF DECISION: 10th September 2018

REASON FOR REFUSAL: The sites have been in a state of disuse during
much of the previous licensed period.

RECRUITMENT

Westport company requires
Machine Operators, General Operatives and Sewing Machinists (Training Provided) for shift working.
 Previous manufacturing experience an advantage but not necessary.
 Applications to info@softbedding.ie

The HELM
 BAR & RESTAURANT
 B&B & SELF-CATERING ACCOMMODATION

Now have vacancies for

- **Bar Staff**
- **Waiting Staff**
- **Kitchen Porters**

Please apply with CV to
 E. thehelm@eircom.net or T. 098 26194

ST. COLMAN'S CARE CENTRE CLG
 KEEL ACHILL CO. MAYO

Wishes to recruit relief staff for the following positions:

- **Staff Nurse / Day Care Manager**
- **Health Care Assistant**

St. Colman's Care Centre provides a broad range of health care and social support services for older people and people with disabilities in the parish of Achill.
 Application Forms and Job Specification details may be obtained from the
Administration Office, St. Colman's Care Centre.
Tel. 098 43248.
Email: kathleengstcolmans@gmail.com
 The closing date for receipt of applications is 5th October 2018

Part-time Bookkeeper Wanted
Newport area (Maternity Cover)

Responsibilities include:

- Debtors billing, payment allocation etc.
- Creditors - invoice posting, payment allocation, creditors reconciliation, processing of payments runs, etc.
- Bank Reconciliation
- Assist with preparation of VAT returns and other tax filings
- General and ad hoc administration and office duties

Ideally looking for someone who has strong experience of bookkeeping
 Apply with CV to BookkeeperNewport@gmail.com

SITUATIONS VACANT

CHEF DE PARTIE in charge of stir fry and sauce making station. Siam Food Ltd - €30,160 p.a. - Lana Asian Street Food, Tucker Street, Castlebar, Co. Mayo. 39 hours per week.

THE TAVERN
 BAR & RESTAURANT

now have vacancies for:
WAITING STAFF
 (Part-Time) Experience essential

Also **SOUS CHEF**
 Please apply with CV to info@tavernmurrisk.com or drop in CV in person



WHERE CROUGH PATRICK MEETS THE WILD ATLANTIC WAY
 MURRISK - WESTPORT - CO. MAYO
 T. 098.64060 W. www.tavernmurrisk.com

Rustic Fork

JAMES STREET, WESTPORT

Now have a vacancy for a
Waiter / Waitress
 Full Time Permanent Position
 Minimum of 1+ years experience

Apply in person or email
rusticfork.westport@gmail.com

Westport House **hotelwestport**

SALES & MARKETING
SUPERSTAR
 WANTED

For more information and to make an application, please visit www.WestportHouse.ie/blog

aran
 WOOLLEN MILLS

are seeking
SEWING MACHINISTS
 to join our team in Westport, Co Mayo.

Key requirements:

- Competent and accurate in the use of industrial sewing machinery
- Previous industrial sewing experience
- Proven ability to meet and exceed targets
- Strong ability to work both individually and as part of a team
- Ability to follow detailed and complex instructions correctly and consistently

These are full-time positions - Monday to Friday hours.
 To apply, please send applications to:
Production Operations Manager, Aran Woollen Mills, Lodge Road, Westport, Co Mayo.

SERVICE CONTRACTORS
 DOMESTIC APPLIANCE REPAIRS

Leading manufacturer of domestic appliances seek to appoint
SERVICE AGENTS
 (Mayo area)

Applications will be on a self-employed basis. A proven track record in the electro mechanical industry.
 Some knowledge of domestic appliance repairs would be an advantage.
 Please apply by September 28 with CV to domesticappliancepairs18.com.

FISHERIES (AMENDMENT) ACT, 1997(No. 23) FORESHORE ACT, 1933(No.12) NOTICE OF DECISIONS TO GRANT/ REFUSE AQUACULTURE AND FORESHORE LICENCES

The Minister for Agriculture, Food and the Marine has decided to grant Aquaculture and Foreshore Licences to those listed in the table below to carry out Aquaculture, on a number of sites on the foreshore in Co. Mayo.

| Ref No | Applicant's Name & Location of Site(s) | Species |
|-----------|--|--|
| T10/221/1 | Martin Coim, Luke and Olivia Henry, Blacksod Bay | Manila & Native Clams & Pacific Oysters |
| T10/237 | Gerard Heneghan, Blacksod Bay | Pacific and Native Oysters, Mussels, and Winkles |
| T10/319 | Redrose Developments Ltd., Broadhaven Bay | Seaweed - various |

The Minister for Agriculture, Food and the Marine has decided to refuse to grant Aquaculture and Foreshore Licences to:

Tony Mc Grath, for the cultivation of Pacific Oysters on the foreshore on 2 sites in Broadhaven Bay

The reasons for these decisions are elaborated on the Department's website at: <http://www.agriculture.gov.ie/seafood/aquacultureforeshoremanagement/aquaculture/licensing/>

An appeal against the decisions may be made in writing, within one month of the date of this publication, to THE AQUACULTURE LICENCES APPEALS BOARD Kilminchy Court, Portlaoise, Co. Laois, by completing the Notice of Appeal application form available from the Board, phone 057 8631912, e-mail at info@alab.ie or website www.alab.ie

A person may question the validity of the Foreshore Licence determination by way of an application for judicial review, under Order 84 of the Rules of the Superior Court (SI No. 15 of 1986). Practical information on the review mechanism can be obtained from the Citizens Information Board at: <http://www.citizensinformation.ie/>

www.agriculture.gov.ie
 @agriculture_ie

An Boine Talmhaíochta, Bia agus Mara
 Department of Agriculture, Food and the Marine

KILMEENA GAA LOTTO Result Sept 13 in The Porter House
JACKPOT €7,800 Numbers drawn: 7, 11, 27, 29
NO JACKPOT WINNER - 5 winners of €20:
 Pat Salmon, Mick O'Malley, Declan Donovan, Robert Coady, Dermot Flaherty.
Next draw in Matt Molloy's, on Sept 20 - Jackpot €7,900
 Thanks for your support



Aqua Culture Sites

<all other values>

Site_Status

- Under Appeal
- Application
- Lapsed
- Licensed
- Refused
- Revoked
- Surrendered
- Withdrawn

1:45,000

**BROADHAVEN BAY,
CO. MAYO.**



**An Roinn Talmhaíochta,
Bia agus Mara**
Department of Agriculture,
Food and the Marine